

A系列外形尺寸图 A SERIES OUTLINE DIMENSION DRAWING

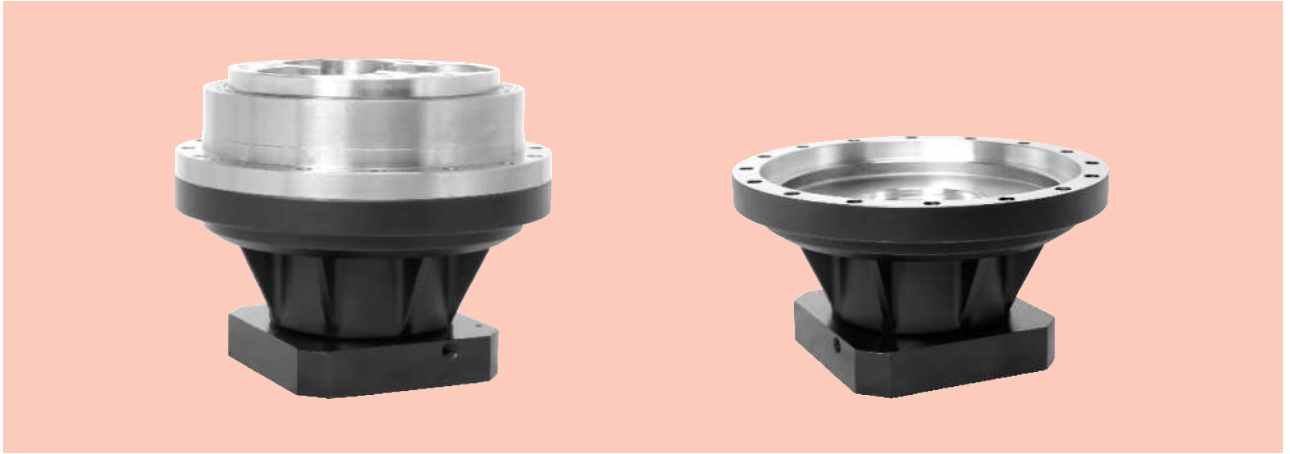

220BX-RVA-35 外形图 220BX-RVA-35 Outline Drawing

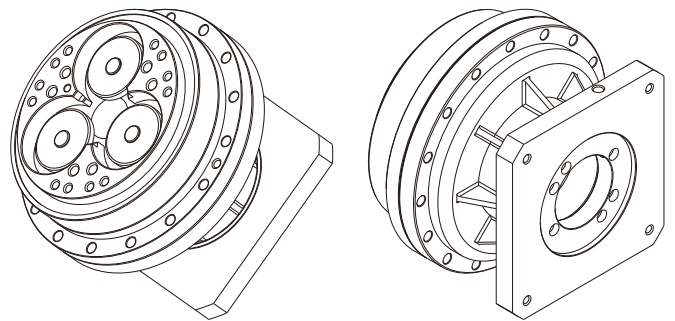
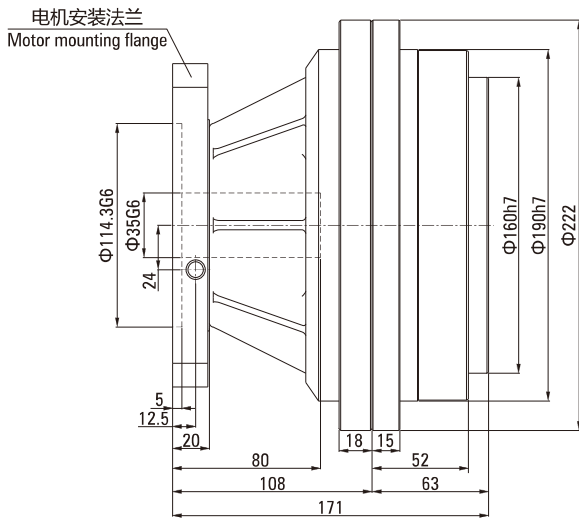
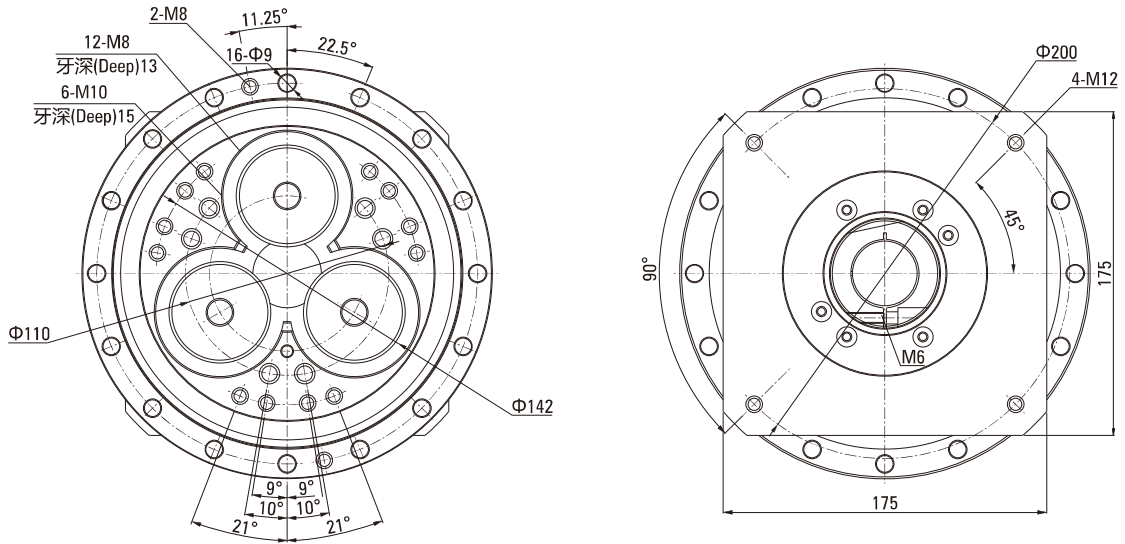

说明 Note:

1. 本图适用电机轴: $\leq 35 \times 80L$; 电机轴用锁紧器锁紧; This figure applies to the motor shaft: $\leq 35 \times 80L$; motor shaft lock use locker;
2. 电机安装法兰依电机型号提供。Motor mounting flange according to motor model.